

AZHS15ECXXA

GE Zonline® Heat Pump Unit with Corrosion Protection, 265 Volt

Features & Benefits

- Cooling Capacity - 14,600 BTU
- Energy Efficiency - 10.4 EER
- Dehumidification - 4.2 Pints/Hour
- Heat Pump Capacity - 13,500 BTU
- Heat Pump Efficiency - 3.4 COP
- Heat Pump Down to 25°F with Reverse Cycle Defrost
- Indoor Fan CFM (High/Low) - 440/305
- Electronic Touch Controls with LED Display
- Quiet Operation - Baked-On Mastic Sound Barrier, Cross Flow Blower and Two DC Fan Motors Create Less Noise to Ensure Comfort
- Corrosion Protection Package - Coated Outdoor Components for Protection in Coastal Environments
- SMC Base Pan and Bulkhead - No Rusting and Helps Block Noise
- Heat & Freeze Sentinels - Keeps the Room from Over-Heating or Freezing
- Boost Heat Option - Provides Supplemental Resistance Heat in Heat Pump Mode
- Electronic Temperature Limiting - Prevents Expensive Over-Cooling or Over-Heating of the Room
- Fresh Air Vent CFM (Fully Open High Fan) -44*
- R 454B Refrigerant

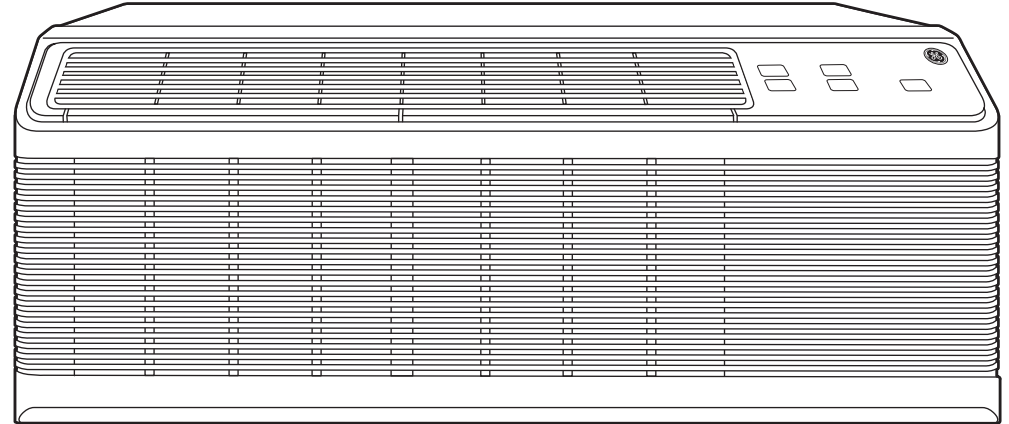

*When Using the RAKVENT1 Kit

Projected Specifications. Subject to Change Without Notice.



GE APPLIANCES

For more information please visit our website at zonline.com or message Hospitality.Direct@geappliances.com.

Specification Revised 2/24

AZHS15ECXXA

GE Zonline® Heat Pump Unit with Corrosion Protection, 265 Volt

Dimensions and Installation Information (In Inches)

Electrical Wiring

All wiring, including installation of receptacle, must be made in accordance with national and local electrical codes and regulations.

Note: Aluminum wiring may pose special problems – consult a qualified electrician.

Grille Options

Stamped Aluminum Grille – RAG60 Exterior Architectural Louvers
Durable Polycarbonate: RAG42PB (Beige), RAG42PM (Maple), RAG42PD (Dark Brown) Extruded Aluminum Architectural Grille – RAG42AA

Retrofit Kits

RAK40 – Deflector Kit to adapt chassis for use with non-GE exterior louvered grilles.

Ducted Applications

AZHS, AZES, & AZVS Series without make-up air can be used with ductwork to heat or cool more than one room. RAK6053 Duct Adapter is applied to the top of case over the air discharge. RAK601B Duct Extension is applied to right or left of adapter. Locally fabricated ductwork may be added to extend to maximum recommended straight distance of 15 feet in one direction.

Electrical Connection

230/208 volt units may be plugged into a receptacle. See Architects and Engineers Design Data Manual for electrical connection information including use of sub-base for direct connected units. Installation must comply with national and local electrical codes and regulations. Power connection kits are required on all Zonline chassis.

Wall Sleeve Dimensions

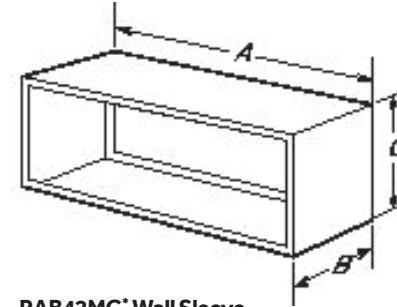

RAB42MG* Wall Sleeve

Heavy-gauge steel, 4 pc design with insulation. A-42", B-13-3/4", C-16" Also available in 16", 18", 20" and 24" depths

RAB42PG Wall Sleeve

4 pc fiberglass reinforced polyester compound with stainless steel locking components. A-42", B-14", C-16"

265-Volt - Permanent (P, CORD Set) and Direct-Connect Units (D)						
BTUh Size	7K/9K			12K/15K		
Power Connection Kit	RAK515P RAK515D	RAK520P RAK520D	RAK530P RAK530D	RAK515P RAK515D	RAK520P RAK520D*	RAK530P RAK530D*
Total Watts	2440	3450	4850*	2460	3470	4870*
Heater Watts	2400	34005	48005*	2400	3400	4800*
Heater BTU	8100	11600	16300*	8100	11600	16300*
Total Amps	9.1	12.9	18.1	9.3	13.1	18.4
(MCA)	15	20	25	15	20	25
Recommended Protective Device (MOCP)	15 amp Time-Delay Fuse or Breaker	20 amp Time-Delay Fuse or Breaker	25 amp Time-Delay Fuse or Breaker	15 amp Time-Delay Fuse or Breaker	20 amp Time-Delay Fuse or Breaker	25 amp Time-Delay Fuse or Breaker

*Heater output reduced on low fan speed.



GE APPLIANCES

For more information please visit our website at zonline.com or message Hospitality.Direct@geappliances.com.

Specification Revised 2/24